

A-28 GALVANIC ISOLATORS

A-28 GALVANIC ISOLATORS

Based on ABYC's assessment of the existing technology, and the problems associated with achieving the goals of this standard, ABYC recommends compliance with this standard for all boats, associated equipment, and systems manufactured and/or installed after July 31, 2009.

28.1 PURPOSE

This is a performance based standard and guide for the qualification and installation of galvanic isolators, and their status monitors, if applicable, in alternating current (AC) electrical systems on boats.

NOTE: Boats with metal in contact with water are subject to galvanic corrosion when connected to shore power as a result of connection to the common AC grounding conductor. This connection will affect the vessel's cathodic protection system. The use of a galvanic isolator may reduce these effects.

28.2 SCOPE

This standard applies to galvanic isolators and their status monitors used on boats equipped with alternating current (AC) shore power systems operating at frequencies of 50 or 60 hertz, and less than 300 volts, wired in accordance with ABYC E-11, AC & DC Electrical Systems on Boats.

28.3 REFERENCED ORGANIZATIONS

ABYC - American Boat & Yacht Council, Inc., 613 Third Street, Suite 10, Annapolis, MD 21403. Phone 410-990-4466 Fax: 410-990-4466 Website: www.abycinc.org.

IEC - International Electrotechnical Commission, 3, rue de Varembé, P.O. Box 131 CH - 1211 GENEVA 20 Switzerland, Phone: +41 22 919 02 11 Fax: +41 22 919 03 00 E-mail: [IEC Central Office](mailto:IEC_Central_Office) website: www.IEC.ch

NEMA - National Electrical Manufacturer's Association, 1300 North 17th St, Suite 1752, Rosslyn, VA 22209. Phone: 703-841-3200, Fax: 703-841-5900. Web site: www.nema.org

UL - Underwriters Laboratories, Inc., 12 Laboratory Drive, PO Box 13995, Research Triangle Park, NC 27709. Phone: 919-549-1400. Website: www.ul.com.

SAE - Society of Automotive Engineers, 400 Commonwealth Drive, Warrendale, PA 15096-0001. Phone: 724-776-4841. Fax: 724-776-0790. Website: www.sae.org.

NFPA – National Fire Protection Association, 1 Batterymarch Park, Quincy, MA 02169 Phone: 617-770-3000 Fax: 617-770-0700 Website: www.nfpa.org

28.4 DEFINITIONS

For the purposes of this standard, the following definitions apply.

AC Grounding Conductor (green or green with yellow stripe) - A protective conductor, which does not normally carry current, used to connect the metallic, non-current carrying parts of electrical equipment to the AC grounding system, engine negative terminal, or its bus, and to the shore AC grounding conductor through the shore power cable AC grounding conductor.

Effective Ground-Fault Current Path - An intentionally constructed, permanent, low-impedance electrically conductive path designed and intended to carry current under ground-fault conditions from the point of a ground fault on a wiring system to the electrical supply source and that facilitates the operation of the overcurrent protection device.

A-28
07/08

Fail Safe Galvanic Isolator – An isolator that, if after meeting all other criteria of this standard, meets the requirements of an effective ground-fault current path when subjected to the test conditions in A-28.14, Table 2.

NOTE: The device may not continue to provide galvanic isolation in the event of a failure.

Galvanic Corrosion - The corrosion that occurs at the anode of a galvanic couple caused by the flow of ions from the anode to the cathode through an electrolyte.

Galvanic Couple - Two dissimilar metals in electrical contact in an electrolyte.

Galvanic Current - The electric current that flows between metals or conductive non-metals in a galvanic couple.

Galvanic Isolator - A device installed in series with the shore power cable AC grounding (green or green with yellow stripe) conductor to block low voltage DC galvanic current flow, but permit the passage of alternating current normally associated with the shore power cable AC grounding (green or green with yellow stripe) conductor.

Independent Laboratory –A laboratory that:

a. is engaged, as a regular part of its business, in performing periodic inspections and tests that are the same as, or similar to, the inspections and qualification tests required for the equipment or material being evaluated,

b. has, or has access to, the apparatus, facilities, personnel, and calibrated instruments that are necessary to inspect and test the equipment or material being evaluated, and

c. is not owned or controlled by:

(1) the manufacturer of the equipment or material to be inspected or tested or any similar equipment or material;

(2) a vendor of the equipment or material to be inspected or tested or a vendor of similar equipment or materials; or

(3) a supplier of materials to the manufacturer.

Status Monitor – An integral or external device that provides an indication of the inability of the galvanic isolator to conduct AC current.

28.5 REQUIREMENTS – IN GENERAL

28.5.1 Galvanic isolators and their status monitors shall be tested by an independent laboratory to establish compliance with this standard.

28.5.2 Galvanic isolators and their status monitors shall be provided with instructions covering installation requirements, including a complete set of electrical instructions with diagrams, and

28.5.2.1 operation and in-service testing requirements, and

28.5.2.2 for galvanic isolators providing studs or nuts for connection, the proper tightening torque of the stud or nut.

28.5.3 All exposed materials used in the galvanic isolator, its status monitor, and mounting hardware shall be corrosion resistant.

28.5.4 Galvanic isolators using diodes shall use a non-polarized capacitor(s), or equivalent method of meeting the requirements of A-28.13.5.

28.5.5 The galvanic isolator shall be designed in such a manner that the galvanic isolator components are electrically isolated from the external housing, so that the galvanic isolator can be mounted directly on a conductive surface.

28.5.6 For all electrical tests, all galvanic isolator components shall be used within the component manufacturer's specified ratings.

EXCEPTION: Fail Safe Test Criteria found in Table 2.

28.6 STATUS MONITORING

28.6.1 The galvanic isolator shall be equipped with an integral or external status monitor that provides an audible or visible indication of failure.

Exception: Fail-Safe galvanic isolators

28.6.2 The monitor shall alert when tested between the wiring terminals on the isolator as a result of the following conditions:

28.6.2.1 the isolator fails to conduct above 2.5 volts DC in both directions or if the isolator fails to open below 1.0 volt DC in both directions, or

28.6.2.2 the shorted or open condition of current carrying components in the ground path.

NOTE: If installed, capacitors are not required to be monitored.

28.6.3 Verification test shall be conducted as specified in 28.13.11.

28.6.4 Status monitors with only audible indication shall not be provided with a means to disable the audible alarm for more than five minutes before resounding so long as the alarm condition continues to exist.

28.6.5 Failure of the status monitoring device shall be indicated by loss of display, indication of a failure or a specific indication.

28.6.6 The status monitor shall test the isolator upon connection to AC shore power and at least once every 24 hours while in operation.

28.7 INSTALLATION

28.7.1 The galvanic isolator shall be connected in series with the shore power cable AC grounding conductor (green or green with yellow stripe) in a manner that no other ground conductor will bypass the isolator back to the shore power ground (see [A-28 Figure 1](#)).

NOTE: In some Community Antenna TV (CATV) systems, there is a possibility of bypassing the galvanic isolator through connection of additional CATV equipment (e.g., amplifier splitters, computer equipment, etc.). Additional isolation may be required on shielded connections.

28.7.2 All AC power inlets and all telecommunication inlets (e.g., cable, phone, etc.) shall be electrically isolated from hull and deck, if conductive, and wired so that no part of the grounding system bypasses the isolator.

28.7.3 The current rating of the galvanic isolator shall not be less than the rating of the main shore power disconnect circuit breaker as installed per [ABYC E-11, AC & DC Electrical Systems on Boats](#).

28.7.4 The galvanic isolator shall be installed in a ventilated, dry and accessible location not to exceed the temperature rating of the unit.

28.7.5 The status monitor shall be installed in an accessible location.

28.7.6 Status monitor indicator(s) for the galvanic isolator shall be visible when operating the AC system.

A-28
07/08

28.7.7 If the status monitor is installed in a location where it will be subjected to rain or spray the enclosure shall have a rating of IP64 or NEMA 4X.

28.7.8 Conductor(s) shall be supported and/or clamped to relieve strain within six inches of the isolator case.

28.8 SINGLE ISOLATOR/ DUAL SHORE POWER CORD APPLICATION

28.8.1 In dual shore power cord applications using a single isolator, the current rating of the galvanic isolator shall not be less than the sum of the ratings of the main shore power disconnect circuit breakers as per ABYC E-11, AC & DC Electrical Systems on Boats.

28.8.1.1 A grounding conductor shall be installed from each individual hull inlet to the AC shore grounding connection on the galvanic isolator.

28.8.1.2 The ampacity of the grounding conductor from the point of connection on the galvanic isolator to the boat's AC grounding system shall not be less than the sum of the ratings of the main shore power disconnect circuit breakers.

28.9 MARKINGS and LABELS

28.9.1 The galvanic isolator and its status monitor shall be marked with the following information:

28.9.1.1 the manufacturer's identification, and

28.9.1.2 the product identification or model number, and

28.9.1.3 the AC electrical system rating in volts and hertz (e.g., 120 VAC, 60 Hz, etc.), and

28.9.1.4 the maximum current rating at 30°C (86°F) if so rated, or at 50°C (122°F) if so rated, and

28.9.1.5 the maximum ambient operating temperature (see A-28.12), and

28.9.1.6 ignition protection marking as follows:

28.9.1.6.1 "Ignition Protected," if applicable, identified by a marking such as "SAE J1171 Marine," or "UL 1500 Marine - Ignition Protected," or "Ignition Protected," or

28.9.1.6.2 "Not Ignition Protected," if applicable. Refer to ABYC E-11, AC and DC Electrical Systems on Boats, for more information, and

28.9.1.7 "Fail-Safe per ABYC A-28" if applicable, and

28.9.1.8 the identification of the independent laboratory that tested the device and the applicable standard.

28.9.2 Fail Safe Isolator Labeling

28.9.2.1 Fail Safe Isolators shall be labeled indicating possible loss of galvanic isolation due to a lightning strike.

NOTE: An example of such a label follows:

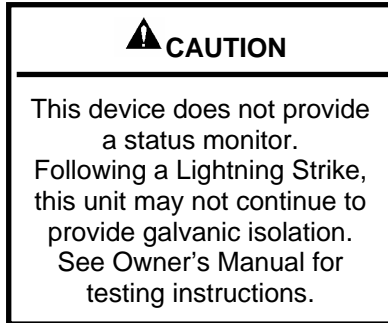

28.10 **IGNITION PROTECTION**

28.10.1 Galvanic isolators and their status monitors located in spaces requiring ignition protection per ABYC E-11, AC & DC Electrical Systems on Boats shall be rated and marked as ignition protected.

28.10.2 Galvanic isolators and their status monitors that are marked as "Ignition Protected" shall meet the requirements of UL 1500 Marine, *Ignition-Protected Test for Marine Products*, or SAE J1171, *External Ignition Protection of Marine Electrical Devices*.

28.11 **ELECTRICAL WIRING AND CONNECTIONS**

28.11.1 The galvanic isolator shall be provided with wiring terminals or wire leads for connection of conductors, having an ampacity that is 135 percent of its nominal rating (e.g., 30 amps x 1.35 = 41 amps).

28.11.1.1 All external conductors shall be in accordance with ABYC E-11, AC and DC Electrical Systems on Boats

28.11.1.2 Quick-connect terminals shall not be used on the AC grounding conductors.

28.11.1.3 If provided, the AC grounding conductor pigtails shall be green or green with a yellow stripe.

28.11.2 The galvanic isolator and its status monitor shall be installed in accordance with ABYC E-11, AC and DC Electrical Systems on Boats.

28.11.3 Friction type connectors on pigtails other than the AC grounding conductors may be used if:

28.11.3.1 the circuit is rated not more than 20 amperes or

28.11.3.2 the manufacturers rating for a terminal meets the requirements of UL 310 "Electrical Quick Connect Terminals", or UL 1059, "Terminal Blocks", and

28.11.3.3 the voltage drop from terminal to terminal does not exceed 50 millivolts for a 20 amp current flow, and

28.11.3.4 the connection does not separate if subjected for one minute to a six pound (27 Newton) tensile force along the axial direction of the connector on the first withdrawal.

NOTE: Circuits used in parallel are considered as the sum of the circuits not the value of the individual components.

28.11.4 For isolators using studs or terminals for the connection of conductors, the tightening torque of the bolt or stud connection shall be included in the installation instructions.

28.11.5 Internal Wiring

28.11.5.1 Strain relief shall be provided for all wiring passing through the galvanic isolator case or its status monitor case to relieve strain on terminals, splices or internal wiring.

NOTE: For testing requirements see 28.13.10.3.1.

28.11.5.2 Solder shall not be the only means of connection for any isolator wiring included in the current carrying components in the ground path.

28.11.5.3 Stud type and terminal block connectors for all isolator wiring shall be the ring or captive spade types.

28.12 **TEMPERATURE**

28.12.1 Galvanic Isolators and their status monitors shall have a minimum rating of 50° C when:

28.12.1.1 ignition protected, and so marked, or

28.12.1.2 intended for installation in machinery spaces.

28.12.2 Galvanic Isolators and their status monitors shall have a minimum rating of 30° C when:

28.12.2.1 not ignition protected, or

28.12.2.2 not intended for installation in machinery spaces, and so marked.

NOTE: For the purposes of rating galvanic isolators and status monitors, the ambient temperature of machinery spaces is considered to be 50°C (122°F), and of all other spaces is considered to be 30°C (86°F).

28.13 **COMPLIANCE TESTING**

28.13.1 The galvanic isolator shall be tested in the sequence outlined in [A-28 Figure 2](#).

28.13.2 The status monitor shall be tested in the sequence outlined in [A-28 Figure 3](#).

28.13.3 AC Conductivity Test

28.13.3.1 The galvanic isolator shall be tested at 100 percent of rated voltage and current, for five minutes using the test procedures outlined in [A-28 Appendix A](#).

28.13.3.2 The galvanic isolator shall not introduce a voltage drop greater than 2.5 volts at 100 percent of the galvanic isolators rated ampacity.

28.13.4 Galvanic Current Blocking Test

28.13.4.1 The galvanic isolator shall be tested for galvanic current blocking using the test procedures outlined in [A-28 Appendix B](#).

28.13.4.2 When a DC voltage of 1.0 volts is applied across the leads of a galvanic isolator, the resultant current shall not exceed 0.030 amperes at an ambient temperature of 25°C (77 °F).

28.13.4.3 The test shall be repeated with the DC voltage applied with the opposite polarity. The resultant current shall not exceed 0.030 amperes.

28.13.5 Galvanic Current Blocking Test with AC Superimposed

28.13.5.1 The device shall be tested for galvanic current blocking with AC superimposed as follows:

28.13.5.1.1 the galvanic isolator shall be tested for its ability to block galvanic current in the presence of an AC voltage superimposed on a DC voltage using the test procedure outlined in [A-28 Appendix C](#); and

28.13.5.1.2 when three amps RMS AC current is superimposed on a DC voltage source of 0.5 volts across the terminals of the isolator, the resultant current shall be no more than 0.005 amperes DC (see [A-28 Appendix C](#)).

28.13.5.1.3 The test procedure, detailed in A-28.13.5.1.2, shall be repeated with the opposite polarity.

28.13.6 Vibration Test

28.13.6.1 The galvanic isolator and its status monitor shall be mounted on a test fixture in such a manner as to simulate a normal installation.

28.13.6.2 The galvanic isolator and its status monitor shall be subjected to a variable frequency vibration in each of the three rectilinear axes (horizontal, lateral and vertical) for four hours in each orientation, and at a peak to peak amplitude of 0.5 mm +/- 0.025 mm (0.020 inches +/- 0.001 inches). The frequency of vibration shall be varied continuously at a uniform rate, from 10 to 60 to 10 Hz every four minutes.

28.13.6.3 On completion of the vibration test, the galvanic isolator and its status monitor shall be examined for structural damage and loose components or terminations that may result in a loss of electrical integrity.

28.13.6.4 The same test article shall then be subjected to the shock test in A-28.13.7.

28.13.7 Shock Test

28.13.7.1 The same galvanic isolator and its status monitor, as subjected to the vibration test, shall be mounted on a test fixture in such a manner as to simulate the manufacturers recommended installation.

28.13.7.1.1 The test fixture shall be mounted on a shock machine and subjected to 5,000 vertical impacts of 10g acceleration (98.2 m/sec²), half sine with a duration of 16-20 milliseconds.

28.13.7.2 On completion of the shock test, the galvanic isolator and its status monitor shall be examined for structural damage and loose components or terminations that may result in a loss of electrical integrity.

28.13.7.3 The same test article shall then be subjected to the temperature test in A-28.13.8.

28.13.8 Temperature Test

28.13.8.1 Galvanic isolators shall be tested at 135 percent of their rated current until the temperature is stabilized (see [A-28 Appendix D](#)).

28.13.8.1.2 The status monitor shall be tested at its designed voltage concurrently with the isolator.

28.13.8.1.3 Galvanic isolators rated for 50 amperes or less shall be tested for one hour at 135 percent of their rated current once temperature stabilization has been determined. Temperature stabilization is defined as temperatures that do not vary more than +/- 5° C over a 30 minute interval.

28.13.8.1.4 Galvanic isolators rated for over 50 amperes shall be tested for two hours at 135 percent of their rated current once temperature stabilization has been determined. Temperature stabilization is defined as temperatures that do not vary more than +/- 5° C over a 30 minute interval.

28.13.8.2 The exterior surface temperature of the galvanic isolator and its status monitor shall not exceed 90°C (194°F).

28.13.8.3 Internal components of galvanic isolators and their status monitors shall not exceed their individual temperature rating.

28.13.8.4 The same test article shall then be subjected to the short circuit test in A-28.13.9.

NOTE: A second modified test article may be added to this test sequence for data acquisition purposes.

28.13.9 Short Circuit Test

28.13.9.1 The galvanic isolator shall be tested for its ability to withstand the application of power from a short circuit test source capable of delivering AC current (RMS) symmetrically through the isolator as specified in Table I.

A-28
07/08

28.13.9.2 Three applications of short circuit current shall be applied to the galvanic isolator being tested. The duration of each short circuit test shall be at least one full cycle. Each short circuit test shall be applied immediately after the test equipment has been reset to the operational mode from the previous test. The electrical and mechanical characteristics of the isolator shall be unchanged.

TABLE I – SHORT CIRCUIT TEST PARAMETERS

Isolator Rating	Fault Current (RMS)	Peak Current
30 amp	3,000 A	4,243 A
50 amp	5,000 A	7,071 A
60 amp	5,000 A	7,071 A
100 amp	5,000 A	7,071 A

28.13.10 Torque & Strain Relief Test

28.13.10.1 Galvanic isolators that provide wiring terminals or studs for connection of conductors shall be tested for tightening torque. The manufacturer shall assign a value of tightening torque considered appropriate for the design of the connector and according to the requirements for the products in which the connector is intended to be used. Test samples are to be prepared using this value of torque.

28.13.10.2 Upon completion of Shock and Vibration tests torque shall be checked and shall be within +/- 10 percent of the manufacturer's recommended tightening torque.

28.13.10.3 Galvanic isolators that provide pigtail conductors for connections of the AC grounding conductor(s) must meet the strain relief test.

28.13.10.3.1 The strain relief means provided on the AC grounding conductor(s) shall withstand for one minute without displacement a direct pull of 35 pounds (155 Newtons) applied to the conductor(s), with the connections within the galvanic isolator disconnected. The strain relief is not acceptable if, at the point of disconnection of the conductors, there is such movement of the conductor(s) as to indicate that stress on the connections would have resulted.

28.13.10.4 The same test article shall then repeat the tests in A-28.13.3, A-28.13.4 and A-28.13.5

28.13.11 Status monitor test -

28.13.11.1 For devices employing diode technology the ability of the status monitor to detect the shorted or open condition of any diode or diode assembly shall be tested as follows;

28.13.11.1.1 in units using a single diode, a single series diode shall be shorted or removed.

28.13.11.1.2 in units using single series diode assemblies in parallel, the parallel diode assembly shall be shorted or removed.

28.13.11.2 For devices not employing diode technology the assembly shall be tested as follows:

28.13.11.2.1 With the application of positive 1.0vdc to the isolator test leads prior to start-up, upon start-up the monitor shall show a PASS.

28.13.11.2.2 With the application of negative 1.0vdc to the isolator test leads prior to start-up, upon start-up the monitor shall again show a PASS.

28.13.11.2.3 With the application of positive 2.6vdc to the isolator test leads prior to start-up, upon start-up the monitor shall show a FAIL.

28.13.11.2.4 With the application of negative 2.6vdc to the isolator test leads prior to start-up, upon start-up the monitor shall again show a FAIL.

28.13.11.3 The ability of the status monitor to test the isolator upon connection to AC shore power shall be confirmed by initiating a failed condition as detailed in 28.6.2.1 before start-up and confirming the indication of fault immediately after start-up.

28.13.11.4 The ability of the status monitor to test the isolator within 24 hours shall be confirmed by initiating a failed condition as detailed in 28.6.2.1 after start-up and confirming the indication of fault within the 24 hour test cycle period.

28.13.11.5 Operational status of the monitoring device will be confirmed by the device failing to operate with removal of any power or sensing wire.

28.14 FAIL SAFE GALVANIC ISOLATOR ADDITIONAL TEST CRITERIA

28.14.1 A galvanic isolator is considered fail-safe if, after meeting all other criteria of this standard, it meets the requirements of an effective ground-fault current path when subject to the test conditions in Table 2.

28.14.2 In addition to the unit that has completed the A-28 qualification testing, an additional 4 test articles will be subjected to this test and the short circuit test in A-28.13.9.

TABLE 2 – TEST CRITERIA FOR A FAIL-SAFE GALVANIC ISOLATOR

Galvanic Isolator Rating, A(rms)	Conductor Size Awg.	Minimum 60 Hz Test Current, A(rms) symmetrical	Conductor Melt I^2t , A ² Seconds	Required Test Time @ Minimum Test Current, Seconds	Required Cycles at Minimum Test Current
30	8	3,000	5,097,229	0.5665	34
50	6	5,000	12,875,605	0.5152	31
60	6	5,000	12,875,605	0.5152	31
100	2	5,000	82,347,942	3.2949	198

Notes:

- $I^2t = [I(\text{peak})^2 \times \text{test time in seconds}] / 2$ where $I(\text{peak})$ is the peak value of the test current (e.g., for a 3,000A test current, $I(\text{peak}) = 3,000 \times 1.414 = 4,242A$)
- A higher test current for shorter time duration may be used to achieve the conductor melt I^2t requirement.
- A conductor two sizes larger than shown in Table 2 shall be required for test purposes so the conductor is not the weak link during test.

FIGURE 1 - ELECTRICAL POSITION OF GALVANIC ISOLATOR - Typical connection diagram for a galvanic isolator.

NOTE: This figure illustrates the position of the galvanic isolator in the circuit, and that the power inlet is electrically isolated from hull and deck, if conductive, and wired so that no part of the grounding system bypasses the isolator. This diagram does not illustrate a complete electrical system. Refer to the appropriate text.

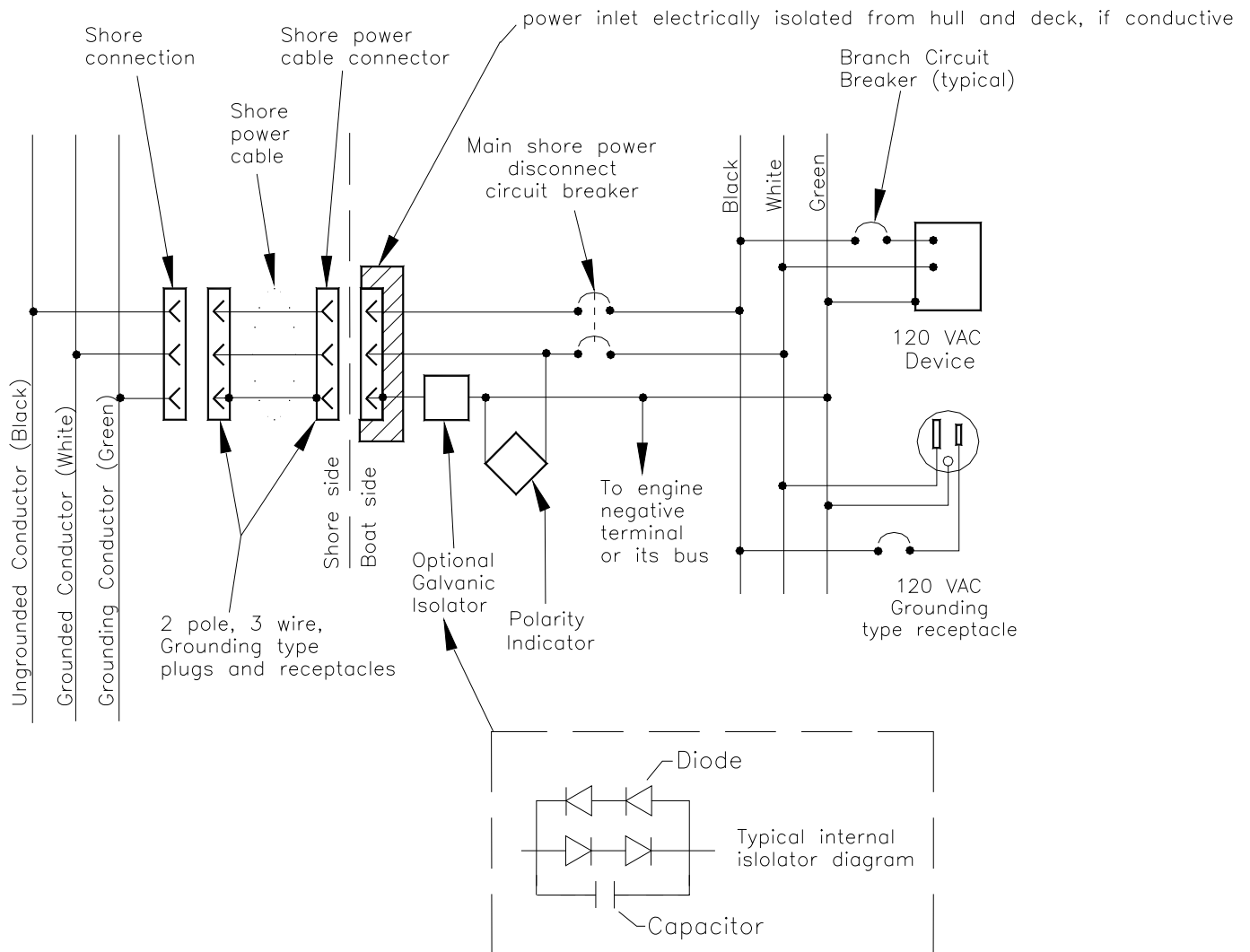

FIGURE 2- GALVANIC ISOLATOR TEST SEQUENCE FOR A GIVEN SAMPLE

NOTE: Galvanic Isolators marked as ignition protected shall meet the requirements of 28.10.2

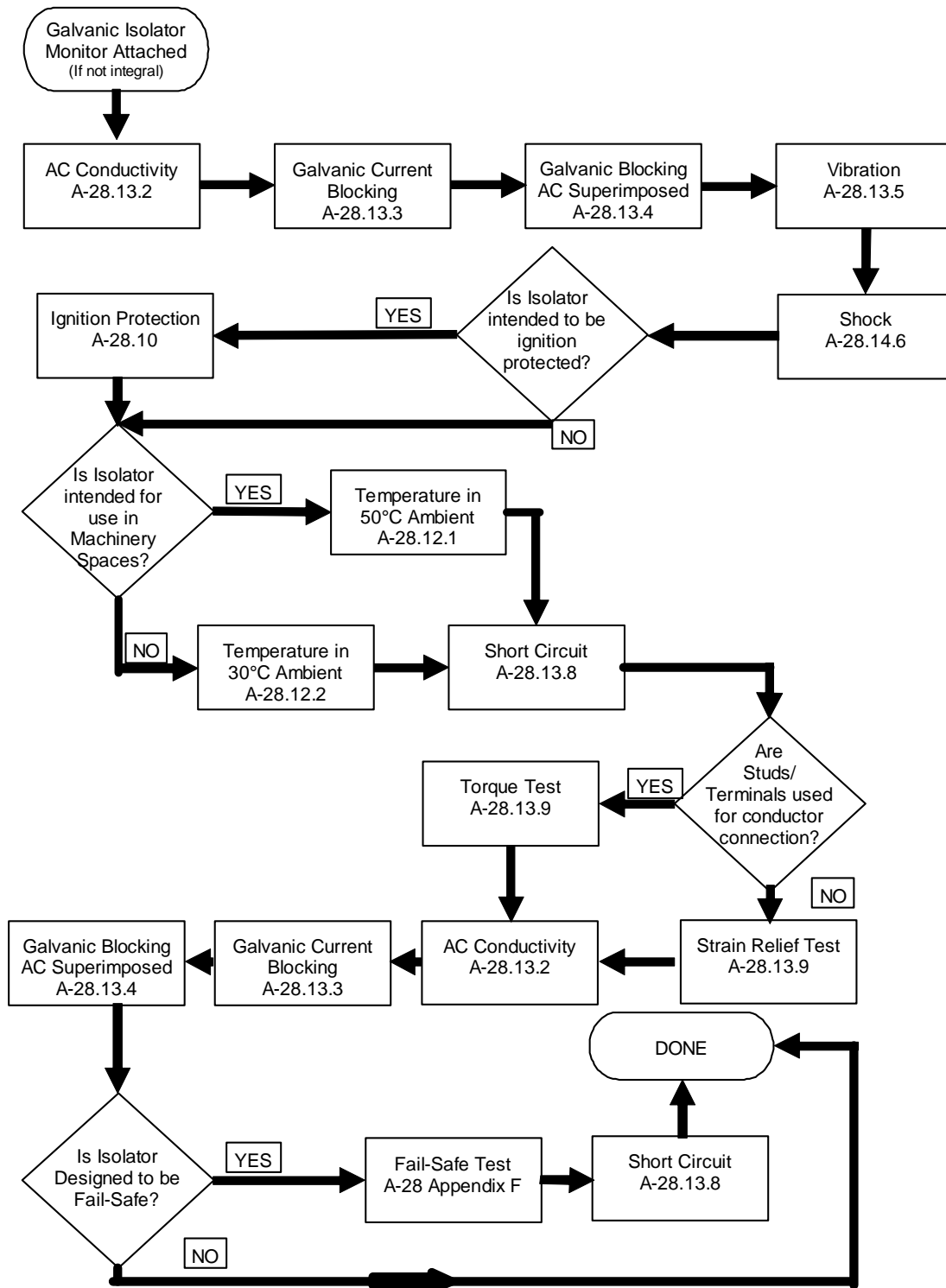
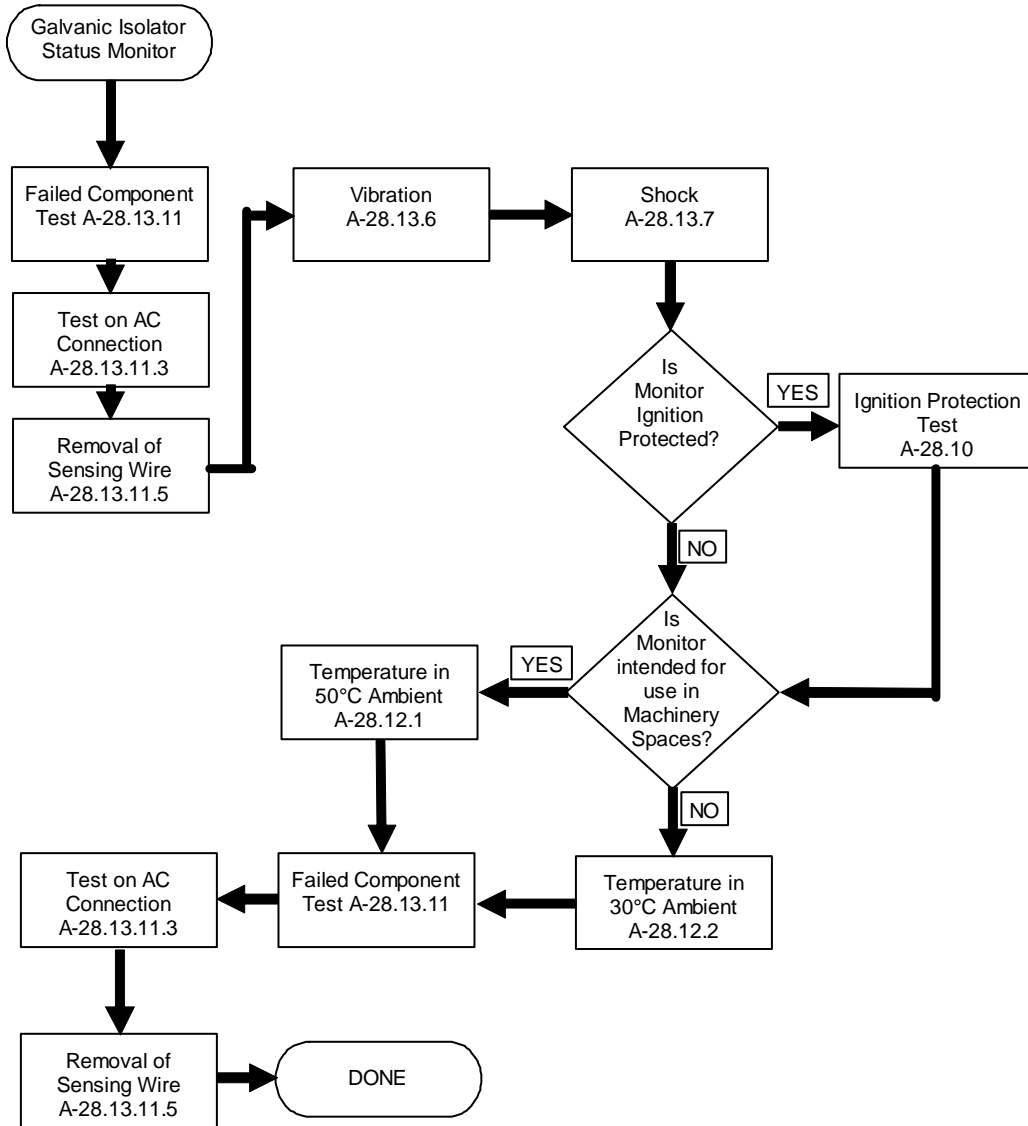
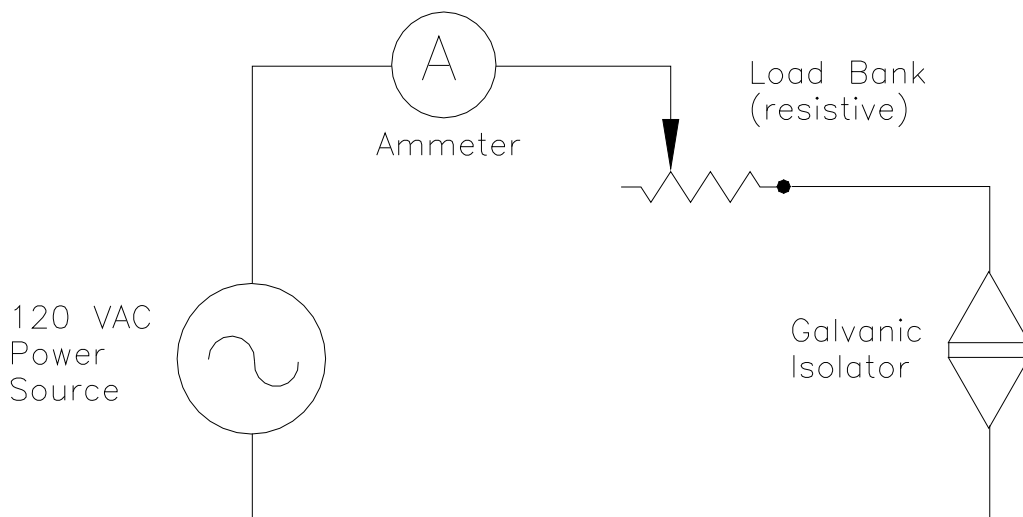

FIGURE 3 - GALVANIC ISOLATOR MONITOR TEST SEQUENCE FOR A GIVEN SAMPLE
NOTE: Status Monitors marked as ignition protected shall meet the requirements of 28.10.2



APPENDIX A - AC CONDUCTIVITY TEST

The galvanic isolator shall be tested at 100 percent of rated voltage and current, for five minutes. in series, connected to a resistive load. The galvanic isolator shall not introduce a voltage drop greater than 2.5 volts at 100 percent of the galvanic isolator ampacity rating. The ammeter shall have a resolution of at least +/- 1 milliampere.



APPENDIX B - ELECTRICAL TEST PROCEDURES FOR GALVANIC CURRENT BLOCKING

The galvanic isolator shall be connected in series with a variable DC power supply as shown below. The supply shall be capable of adjusting the voltage output in fine increments in establishing the exact barrier voltage or intrinsic junction voltage. Once the device is biased into conduction, measurements shall be taken of the resultant current. The ammeter shall have a resolution of at least +/- 1 milliampere. The voltmeter shall have a resolution of at least +/- 1 millivolt. The connection diagram is shown below. See section 28.13.4.1 – 28.13.4.3

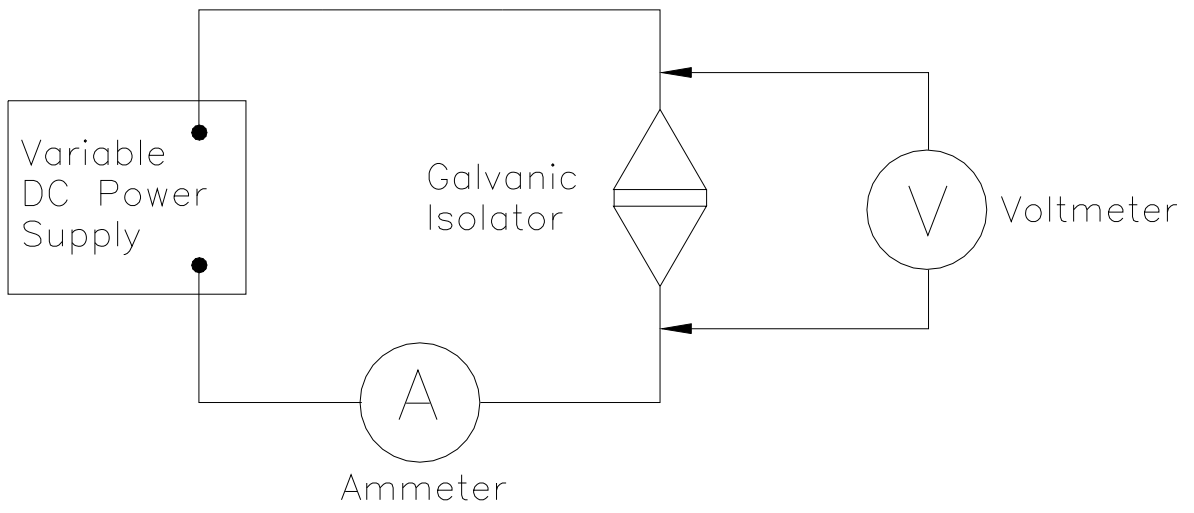

APPENDIX C - GALVANIC CURRENT BLOCKING WITH AC SUPERIMPOSED

The purpose of this test is to confirm that a small AC voltage, which can exist dockside when superimposed on a DC voltage created by galvanic potential between two metals, can bias the device to a higher level of conduction, thereby increasing galvanic corrosion.

The circuit consists of a variac, step down isolation transformer, 25,000 μ f bypass capacitor, DC power supply, load resistor and galvanic isolator. The ammeter shall have a resolution of at least +/- 1 milliampere and the voltmeter shall have a resolution of at least +/- 1 millivolt.

The AC voltage should be increased until an AC current (RMS) of three amps is measured through the isolator. The DC supply is adjusted so that a DC potential of 0.50 volts is measured across the terminals of the isolator. The resultant DC current through the isolator shall not be in excess of 0.005 amperes.

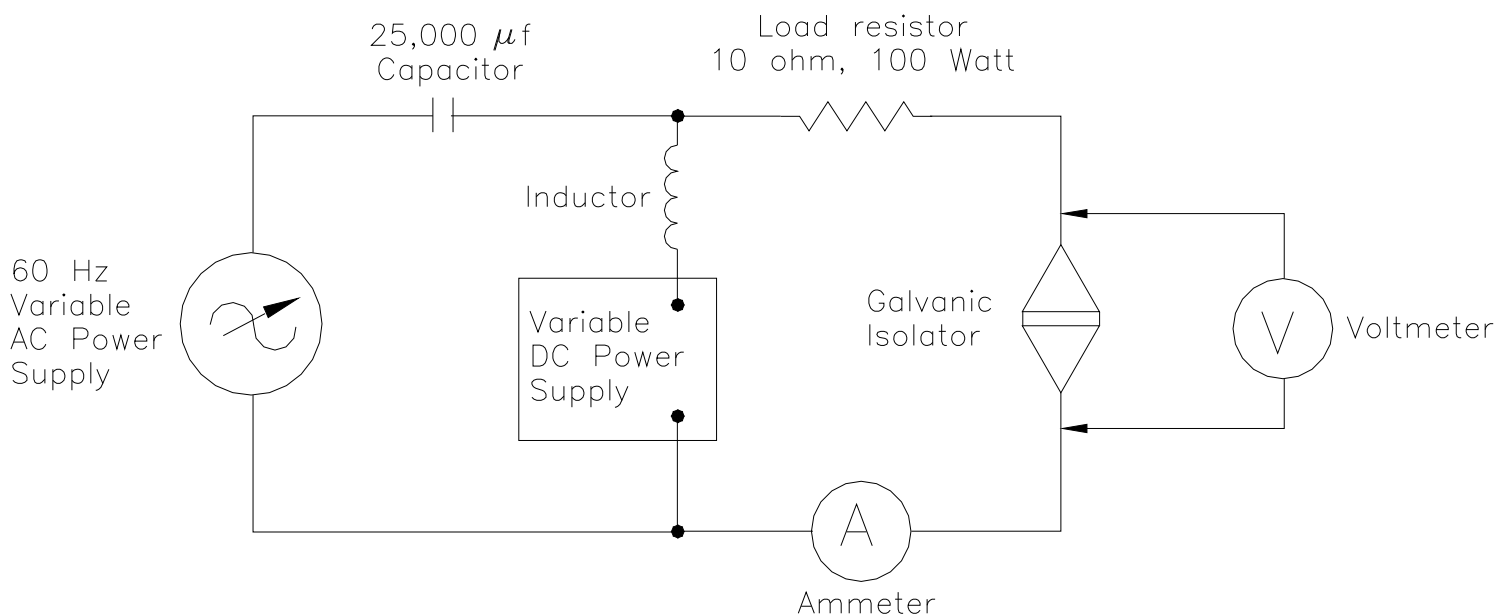

APPENDIX D - LOAD TEST (135 PERCENT) vs. TEMPERATURE

Thermocouples shall be placed in critical locations on the isolator body and its internal components. The isolator shall be mounted as intended on a 1/2-inch piece of plywood. The unit shall be placed in series with an AC power supply, ammeter, and load resistor as shown. The power supply shall be adjusted to allow 135 percent of rated current to be conducted through the isolator. The current shall be maintained until temperatures stabilize. The galvanic isolator shall be designed so that no exterior surface exceeds 90°C (194°F).

All data shall be recorded using a digital temperature and computerized data logger. The ammeter shall have a resolution of at least +/- 1 milliampere.

For galvanic isolators that are not intended for installation in machinery areas or ignition protected areas, the thermocoupled sample shall be preconditioned for two hours in an air circulating oven capable of maintaining an ambient temperature of 30°C (122°F) +/- 2°C. The above test sequence is to be conducted with the sample remaining in the 30°C (122°F) +/- 2°C ambient for the duration of the test.

For galvanic isolators that are intended for installation in machinery areas or ignition protected areas, the thermocoupled sample shall be preconditioned for two hours in an air circulating oven capable of maintaining an ambient temperature of 50°C (122°F) +/- 2°C. The above test sequence is to be conducted with the sample remaining in the 50°C (122°F) +/- 2°C ambient for the duration of the test.

NOTE: For the purposes of rating galvanic isolators, the ambient temperature of machinery spaces is considered to be 50°C (122°F) +/- 2°C, and of all other spaces is considered to be 30°C (86°F).

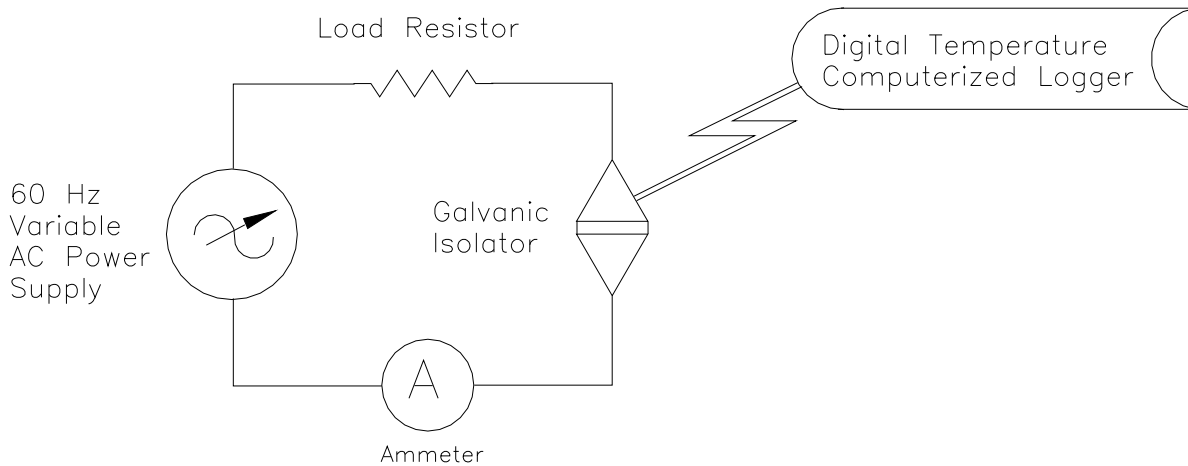

APPENDIX E - SHORT CIRCUIT TEST

The galvanic isolator shall be tested for its ability to withstand the application of power from a short circuit test source capable of delivering AC current (RMS) symmetrically through the isolator as specified in Table I.

Three applications of short circuit current shall be applied to the galvanic isolator being tested. The duration of each short circuit test shall be at least one full cycle. Each short circuit test shall be applied immediately after the test equipment has been reset to the operational mode from the previous test. The electrical and mechanical characteristics of the isolator shall be unchanged.

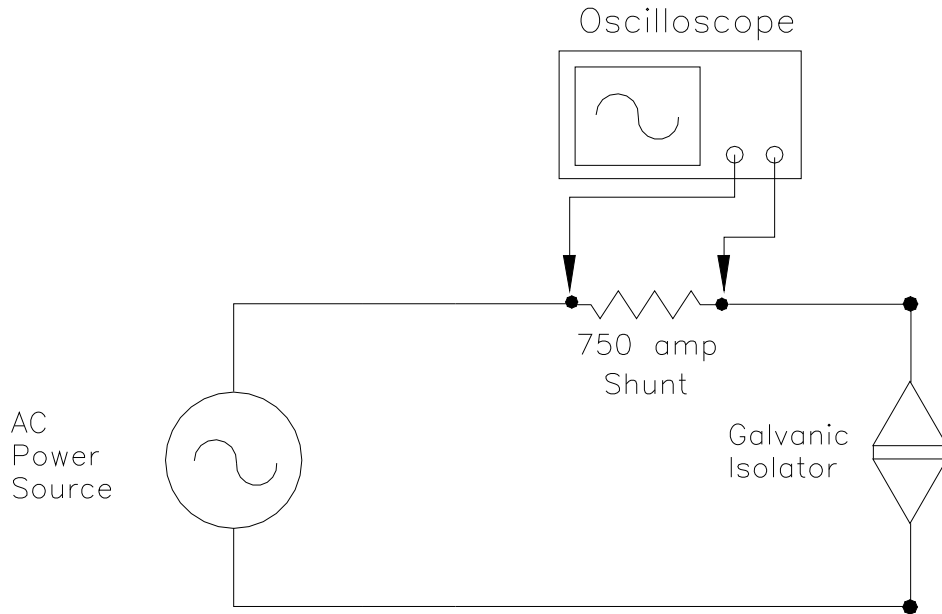

* * * * *

Origin and Development of ABYC A-28, Galvanic Isolators.

ABYC published the first edition of A-28 in 1997 and corrections were issued in 1998, 2001, 2003 and 2004. The July, 2008 update is the work of the Galvanic Isolators Project Technical Committee.

* * * * *

ABYC technical board rules provide that all reports, including standards and technical information reports, are advisory only. Their use is entirely voluntary. They represent the consensus of knowledgeable persons, currently active in the field of small craft, on performance objectives that contribute to small boat safety.

The American Boat & Yacht Council assumes no responsibility whatsoever for the use of, or failure to use, standards and technical information reports promulgated by it, their adaptation to any processes of a user, or any consequences flowing therefrom.

Prospective users of the standards and technical information reports are responsible for protecting themselves against liability for infringement of patents.

The American Boat & Yacht Council standards and technical information reports are guides to achieving a specific level of design or performance, and are not intended to preclude attainment of desired results by other means.